

PLAN REVIEW AND CONSTRUCTION STATUS REPORT - MARCH 2019



SUMMARY OF PROJECTS IN DESIGN OR UNDER CONSTRUCTION



Overall Project Map



***THE FOLLOWING ARE NEW DEVELOPMENT DRIVEN
PROJECTS IN VARIOUS STAGES OF DESIGN/PLAN REVIEW:***

- **PROJECT NAME:** Summit Ridge Middle School Water Relocation
- **LOCATION:** Northwest Corner of S. Simms and Coal Mine
- **STATUS:** Design in progress, Easement Recorded, Old pipe abandoned
- **SCOPE:** Jefferson Co School Project; Adding Class Space



PROJECT LOCATION

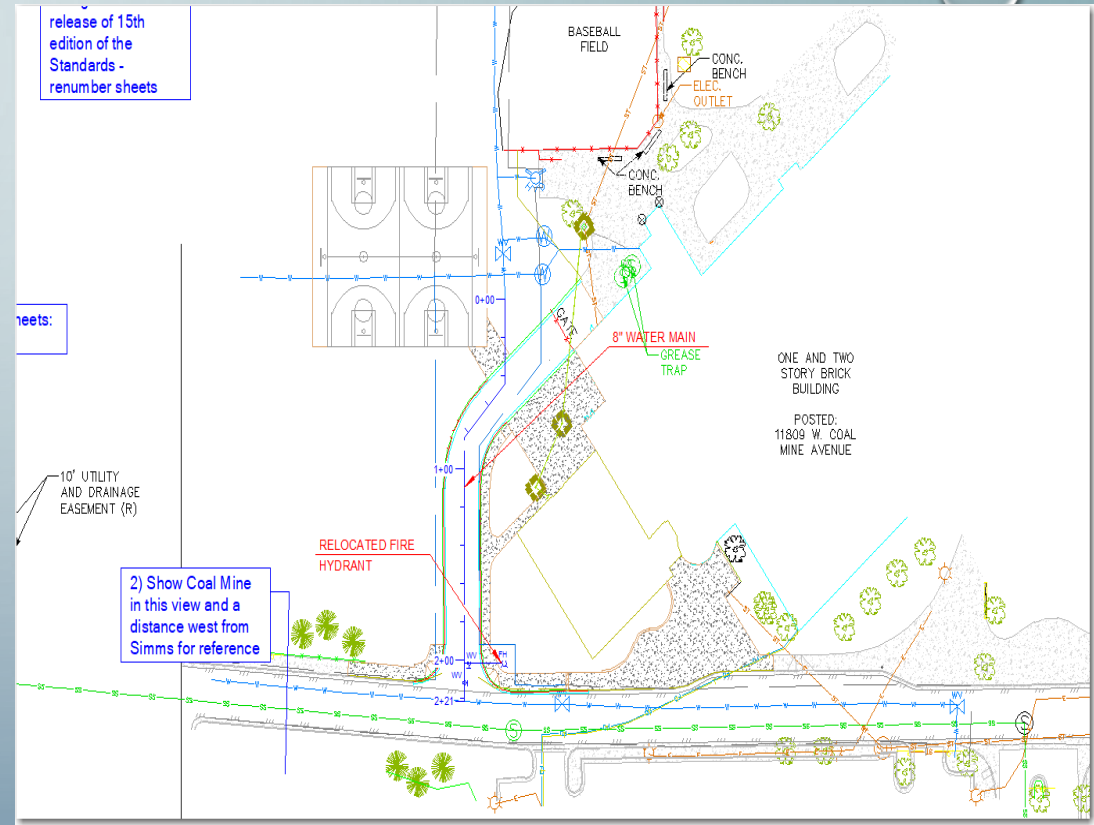

PROJECT PLAN

release of 15th edition of the Standards - renumber sheets

heets:

2) Show Coal Mine in this view and a distance west from Simms for reference

- **PROJECT NAME:** Ken Caryl Center (old Safeway)
- **LOCATION:** SE Corner Ken Caryl and Pierce
- **STATUS:** Conceptual; Commercial Development
- **SCOPE:** Commercial – SDP Submitted to Jeffco

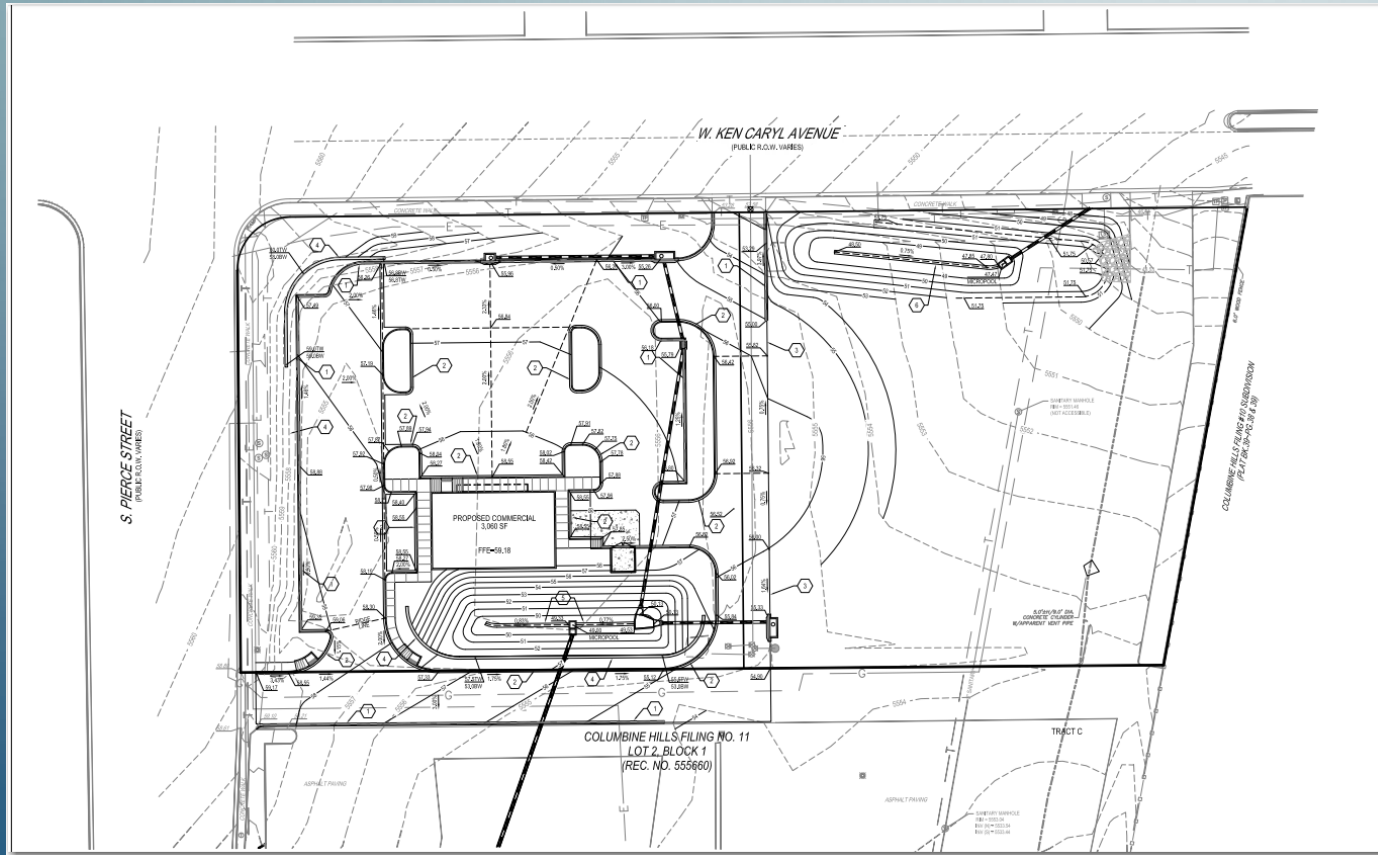

SITE PLAN



PROJECT LOCATION

- **PROJECT NAME:** Platte Canyon Development
- **LOCATION:** Platte Canyon Rd and Depew St
- **STATUS:** Conceptual
- **SCOPE:** 165 Unit Single Family



PROJECT LOCATION

Design Issues:

- **Shallow sewer pipe**
- **Need capacity study**
- **Crossing ditch & shallow depth**



PROPOSED ROUTE FOR SEWER

- **PROJECT NAME:** Bow Mar South
- **LOCATION:** Bowles & Sheridan
- **STATUS:** Conceptual
- **SCOPE:** 90 Unit Single Family

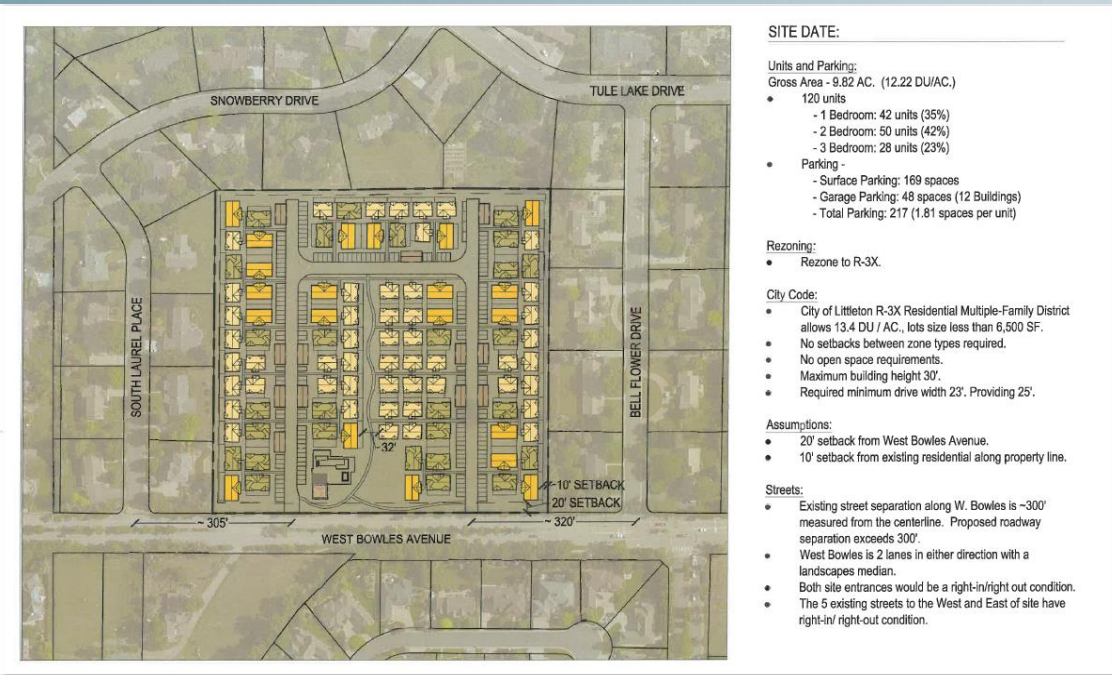

PROJECT LOCATION

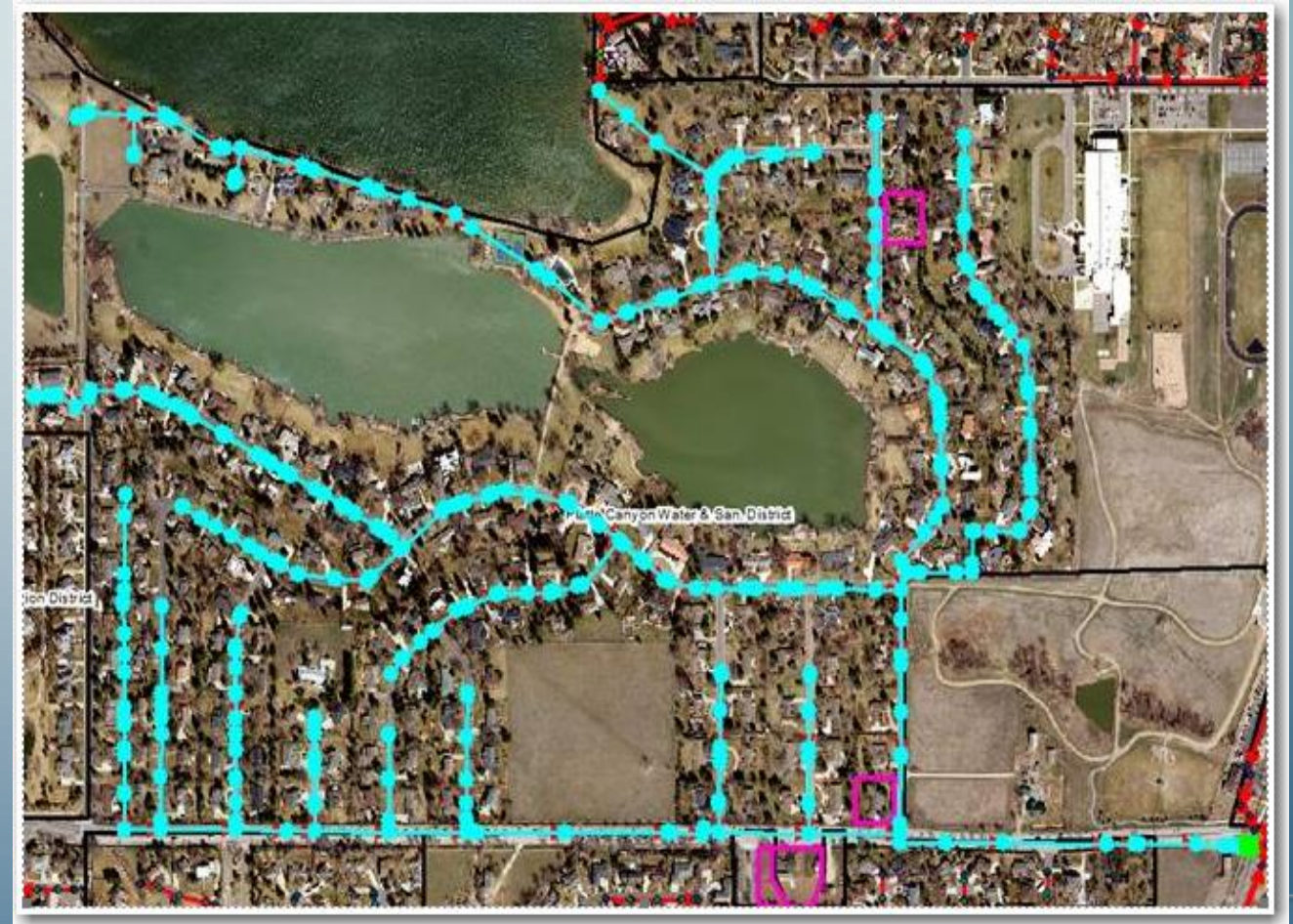

CAPACITY STUDY



***THE FOLLOWING ARE DEVELOPMENT PROJECTS IN
VARIOUS STAGES OF CONSTRUCTION OR REVIEW***

- **PROJECT NAME:** Ken Caryl Middle School Hydrant
- **LOCATION:** Northwest Corner of S. Simms and Coal Mine
- **STATUS:** Scheduled Construction Date 3/25/19
- **SCOPE:** Jefferson Co School Project; Adding Class Space



PROJECT LOCATION

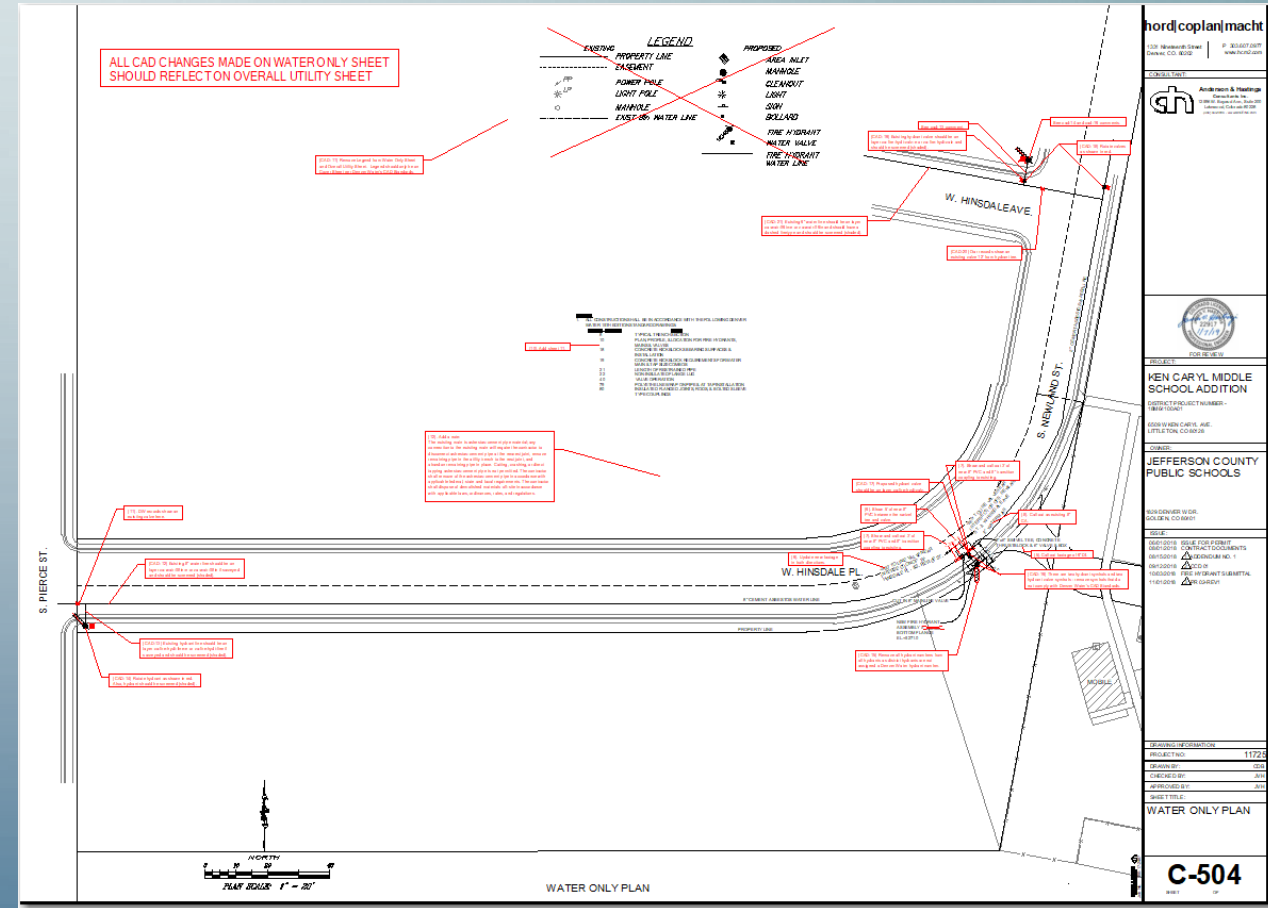

Denver Water CAD Comments

- **PROJECT NAME:** Silverleaf
- **LOCATION:** SW Corner of Coal Mine and Kipling
- **STATUS:** Ready for Construction
- **EFFORT:** Developer – Boulder Creek Developers



Over Excavation



Laying New C-900 PVC Sewer Main Using Expansive Soil Backfill Requirements

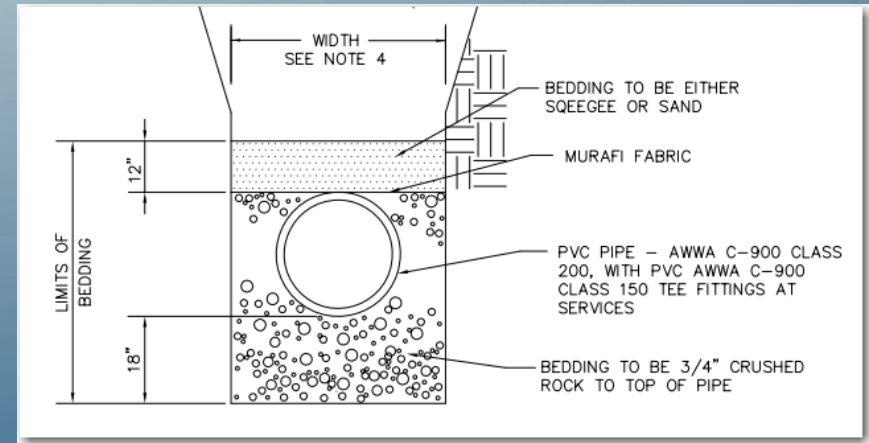

Expansive Soil Detail

- **PROJECT NAME:** Wild Plum
- **LOCATION:** East of S. Platte Canyon Rd and W. Hunter Run Ln.
- **STATUS - Sewer:** Sewer pipe installation complete – Obtaining as-builts
- **Water:** Installation complete – Obtaining as-builts
- **B-Line Sewer manhole lowering**
- **SCOPE:** Water and Sewer Main Installation (9000' each)

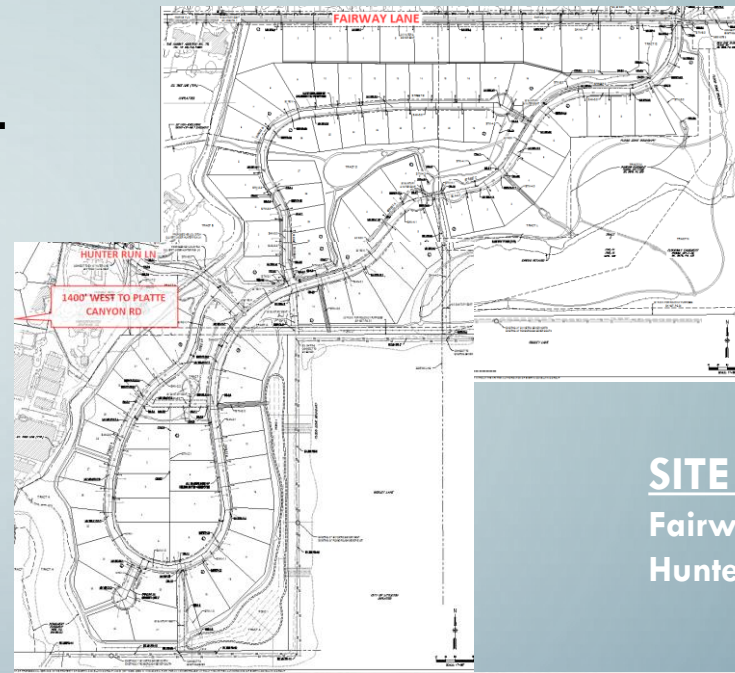

SITE ACCESS

Fairway Ln – North
Hunter Run Ln - West



Manholes on B-Line to be lowered



3-Way Service Connection to End Manhole

- **LOCATION:** 7925 S. Platte Canyon Rd.
- **PROJECT NAME:** Sport Court (volleyball facility)
- **STATUS:** Plan Review pending Fee Payment
- **EFFORT:** Commercial Gym – Private Volley Ball Leagues
- **Issues –** Crossing 48" Denver Water Conduit



Project Location 7925 S. Platte Canyon Rd

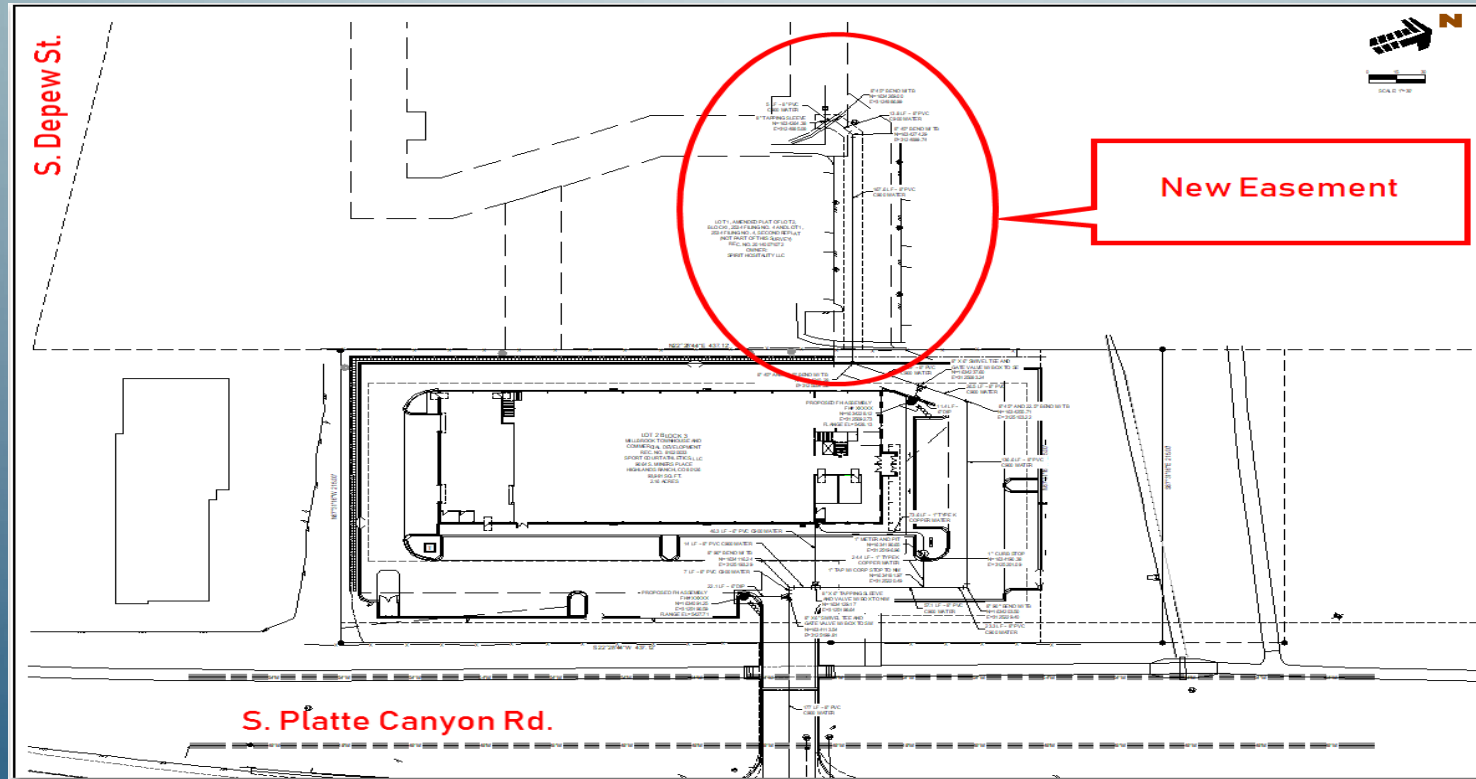

Project Plan

THE FOLLOWING ARE 2018 CAPITAL PROJECTS IN CONSTRUCTION

Valley Sewer Rehabilitation- Best option route – Lift station and force main around landfill
Status – Working with Dewberry on design

- Preliminary Schedule:
 - Design January to May – 2018
 - SRF Loan Application January to June 2018
 - CDPHE Review June – September 2018
 - Finalize Plans, Bid and Award – Sept 2018 –Feb 2019
 - Construction March – September 2019



Project Site



Clogged Storm Drain Downstream of Landfill

PROJECT NAME: SCOTT J. MORSE PUMP STATION

PURPOSE: Enclose new and existing property with fence/wall, grade and pave, install storage bins.

STATUS: Sign Installation **Jeffco Requiring a SDP**



Public Hearing

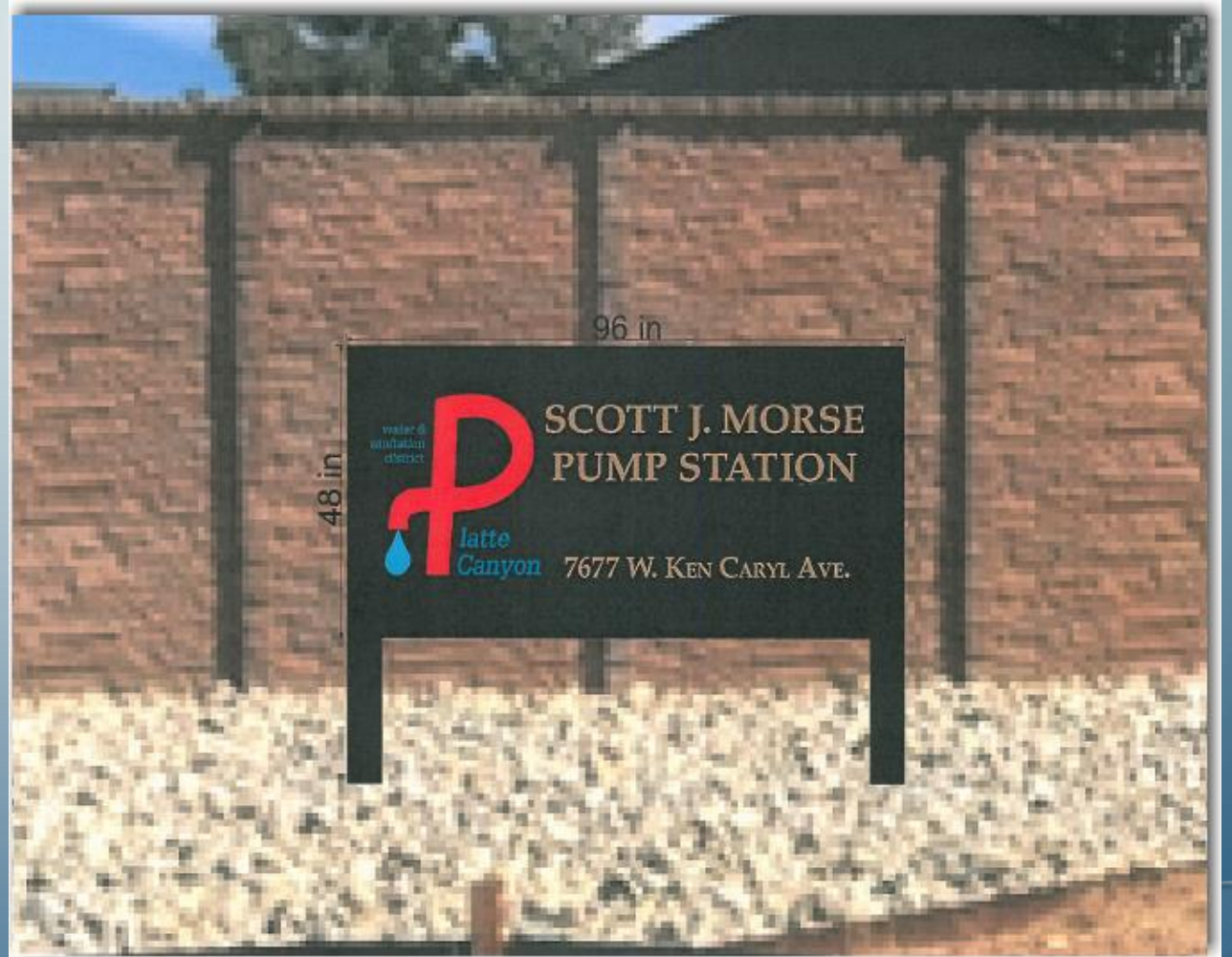

Proposed Steel Sign

THE FOLLOWING ARE 2019 CAPITAL PROJECTS IN DESIGN

- **LOCATION:** S. Jay Ct. Between W. Bowles Ave & W. Leawood Dr
- **PROJECT NAME:** CIP 19-1W
- **STATUS:** In Design
- **EFFORT:** 8-inch Water Main Replacement – 1058 LF, 8-in PVC



- **LOCATION:** S. Jay Dr. Between W. Elmhurst Ave and W. Monticello Ave.
- **PROJECT NAME:** CIP 19-2W
- **STATUS:** In Design
- **EFFORT:** 6-inch Water Main Replacement -732 LF, 6-in PVC

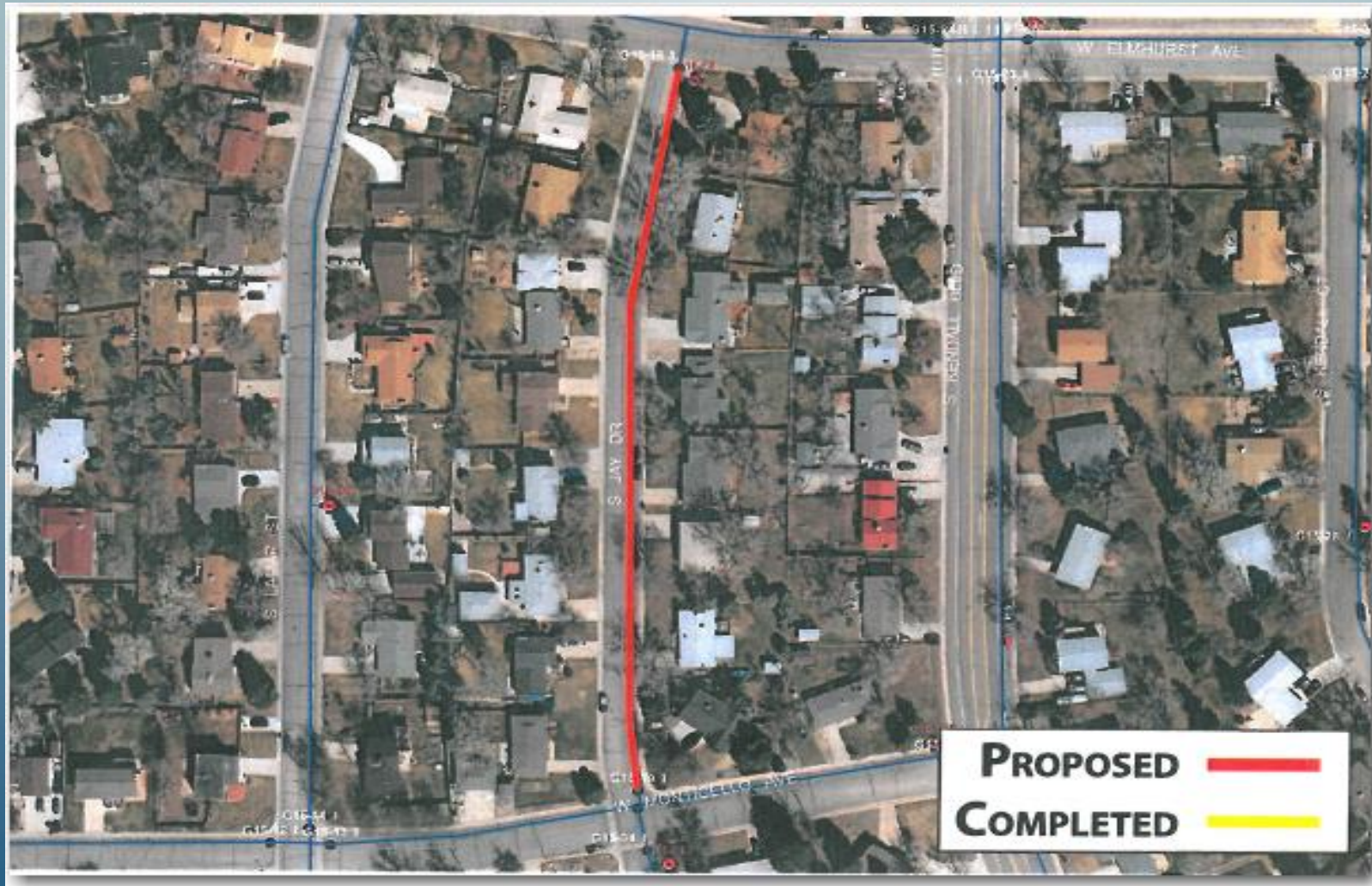

- **LOCATION:** W. Rowland Pl between S. Depew St and S. Sheridan Ct.
- **PROJECT NAME:** CIP 19-3W
- **STATUS:** In Design
- **EFFORT:** 8-inch Water Main Replacement - 1255 LF, 8-in PVC



- **LOCATION:** W. Leewood Dr. between S. Pierce St. and W. Fair Ave.
- **PROJECT NAME:** CIP 19-4W
- **STATUS:** In Design
- **EFFORT:** 8-inch Water Main Replacement - 2319 LF, 8-in PVC



The background is a smooth blue gradient, transitioning from a lighter blue at the top to a darker blue at the bottom. Scattered across the background are numerous water droplets of various sizes and shapes, some appearing as simple circles and others as more complex, irregular shapes. The droplets have a glossy, reflective surface, with highlights and shadows that give them a three-dimensional appearance. They are distributed across the frame, with a higher concentration in the top-left and bottom-right corners.

QUESTIONS?